

STEREO INTEGRATED AMPLIFIER

# A-56/76

## SERVICE MANUAL

# AK25

# KENWOOD

64529

64530

©1992-7 PRINTED IN JAPAN  
B51-4549-00 (B) 2365

[A-56]

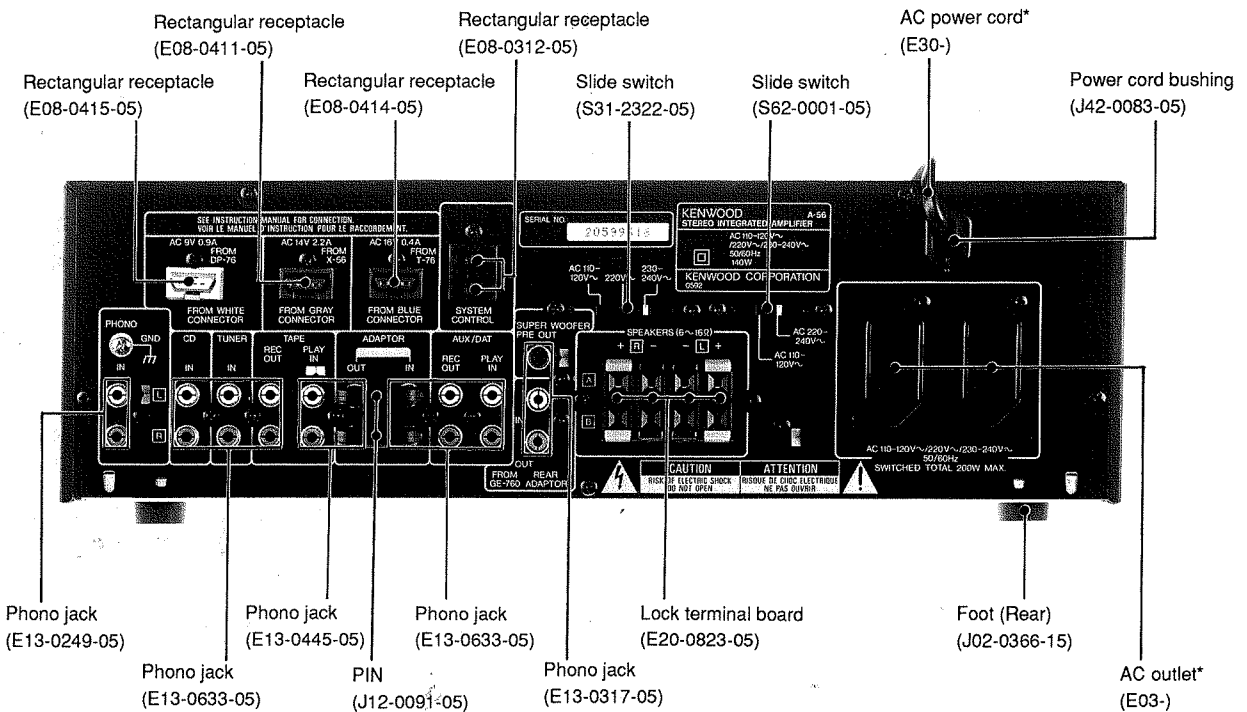
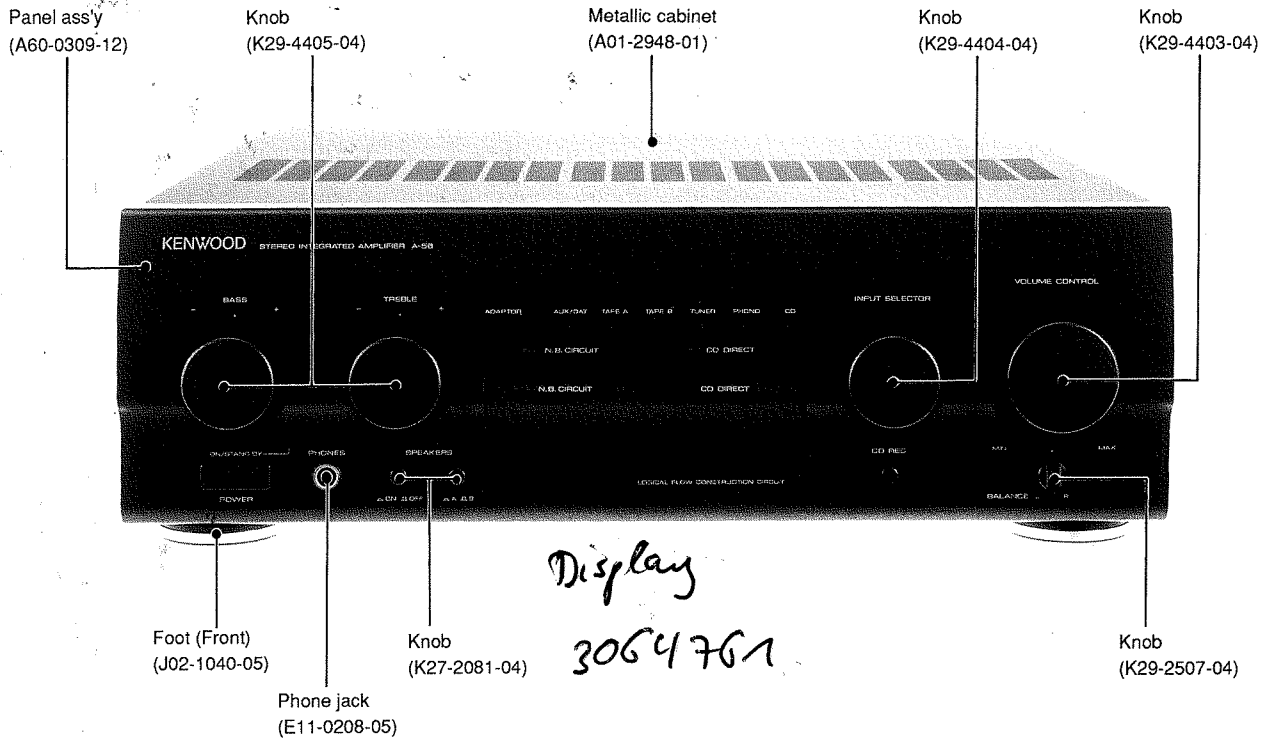

\* Refer to Parts list on page 28.

2  
3  
4  
5  
6  
7

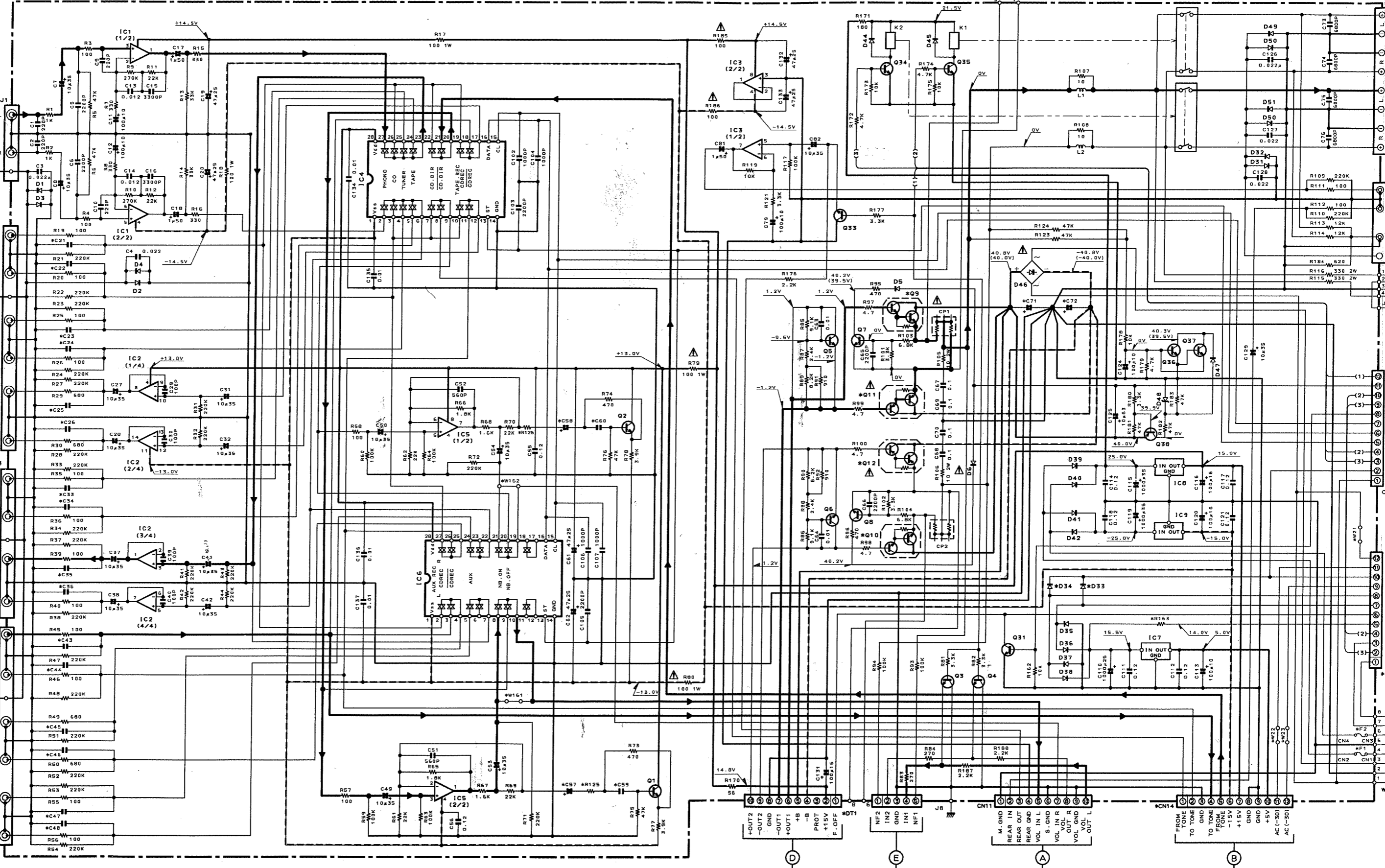

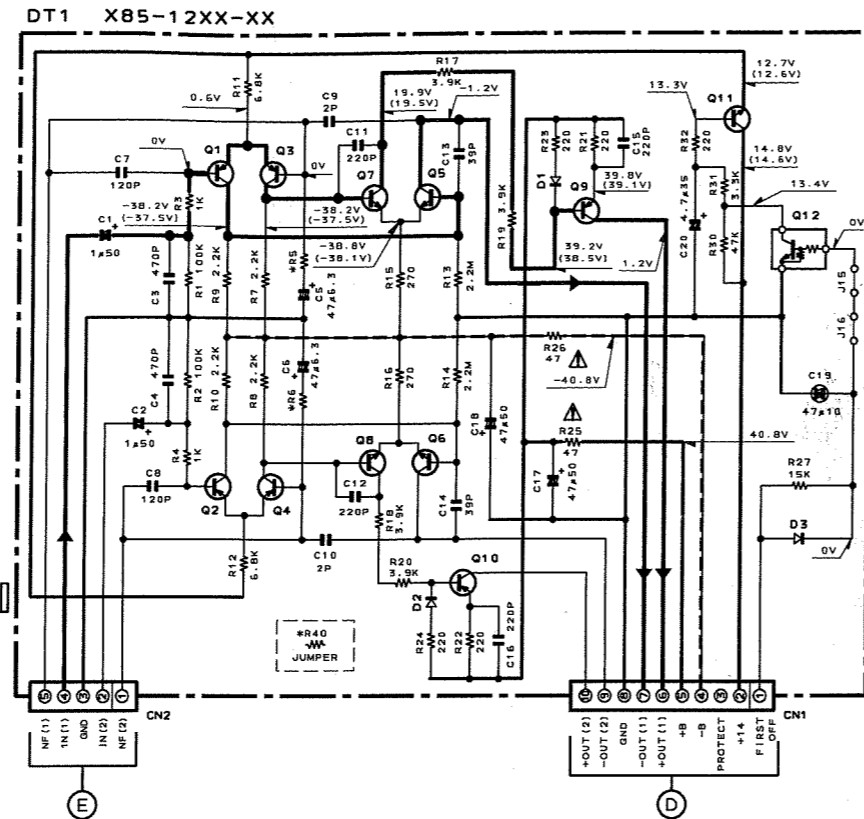
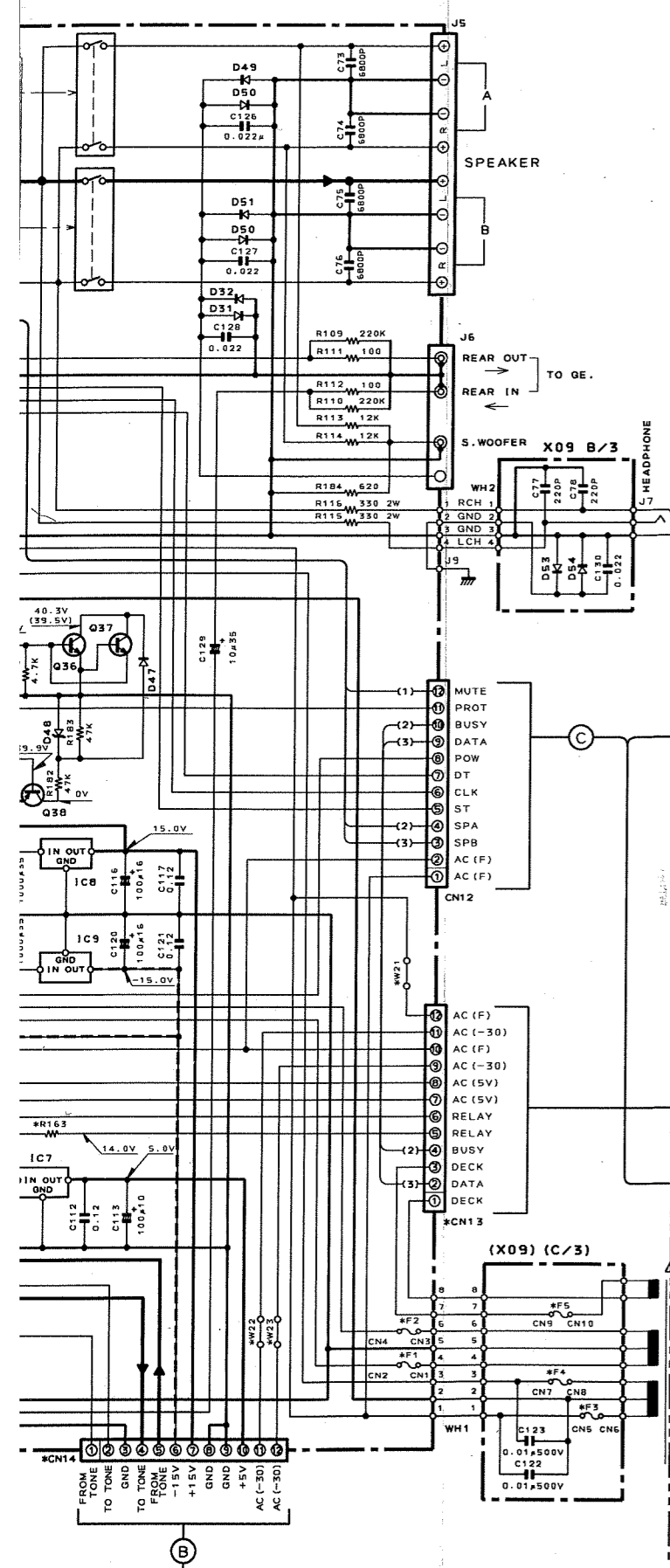

- (X85-12XX-XX)
- Q1~4, 9 : 2SA992 (F.E)  
 10, 13 : 2SC2458 (Y.GR)  
 Q5-8 : 2SC1845 (F.E)  
 Q11 : 2SC3311A (QR) (J)  
 or 2SC1740S (QR)  
 or 2SC2785 (F.E) (S)  
 Q12 : UN4212 or DTC124ES
- (X09-363X-XX)
- IC1, 3, 5 : NUM4565D-D or BA15218-DX  
 IC2 : UPC4574C or NJM2058D  
 IC4 : NJU7313L or TC9164N  
 IC6 : NJU7311L or TC9162N  
 IC7 : TA7805S or  $\mu$ PC7805AHF  
 IC8 : TA7815S or  $\mu$ PC7815AHF  
 IC9 : TA7915S or  $\mu$ PC7915HF
- Q5, 6 : 2SC4137 (V.W)  
 Q9, 10 : 2SD2254 (A-76) 2SD2340 (A-56)  
 Q11, 12 : 2SB1492 (A-76) 2SB1531 (A-56)  
 Q31, 34~37 : 2SC2003 (L.K)  
 Q38 : 2SA933S (Q.R) or 2SA1175 (F.E)
- D1~6, 31, 34 : 1SS133 (Q.R) or HSS104  
 44, 45, 47, 49~54 : S5688B or 1SR139-100  
 D35~42 : RBV-602LFA or D55BA20F03  
 D46 : RD4.7ES (B2) or HZ54.7N (B2)

(X09-363X-XX)

MODEL	COUNTRY	CN13	CN14	Q9.10	Q10.11	D33.34	C21-26 33-36, 43-48	C57.58	C59.60	C71.72	R125	R126	R163	F3.4	W21-23	
A-76 (JAPAN MADE)	M	GENERAL MARKET	0-23	12P	12P	2SD2254	2SB1492	NO	4.7 $\mu$ 35	0.33 $\mu$	6800 $\mu$ 63	W165	W164		YES	
	X	AUSTRALIA	2-72	12P	12P	2SD2254	2SB1492	220P	1.0 $\mu$	0.33 $\mu$	6800 $\mu$ 63	4.7K	4.7K		YES	
	T	ENGLAND												47 2W	T4A L	
A-76 (SINGAPOLE MADE)	M	GENERAL MARKET	0-21	12P	12P	2SD2254	2SB1492	NO	4.7 $\mu$ 35	0.33 $\mu$	6800 $\mu$ 63	W165	W164		YES	
	X	AUSTRALIA	2-70	12P	12P	2SD2254	2SB1492	220P	1.0 $\mu$	0.33 $\mu$	6800 $\mu$ 63	4.7K	4.7K		YES	
	T	ENGLAND														
A-56	M	GENERAL MARKET	0-22	8P	10P	2SD2340	2SB1531	1SS133 or HSS104	NO	4.7 $\mu$ 35	0.1 $\mu$	5600 $\mu$	W165	W164		NO
	X	AUSTRALIA	2-71	8P	10P	2SD2340	2SB1531	220P	1.0 $\mu$	0.33 $\mu$	5600 $\mu$	2.0K	2.0K	82 2W	T2.5A L	
	T	ENGLAND														

(X85-12XX-XX)

MODEL	RS.6	R40
A-76 JAPAN MADE	20-01 2.37K	10
X	20-00 2.15K JUMPER	
T		
A-76 SINGAPOLE MADE	30-01 2.37K	10
X	30-00 2.15K JUMPER	
T		
A-56	30-03 2.87K	33
X	30-02 2.61K	22
T		

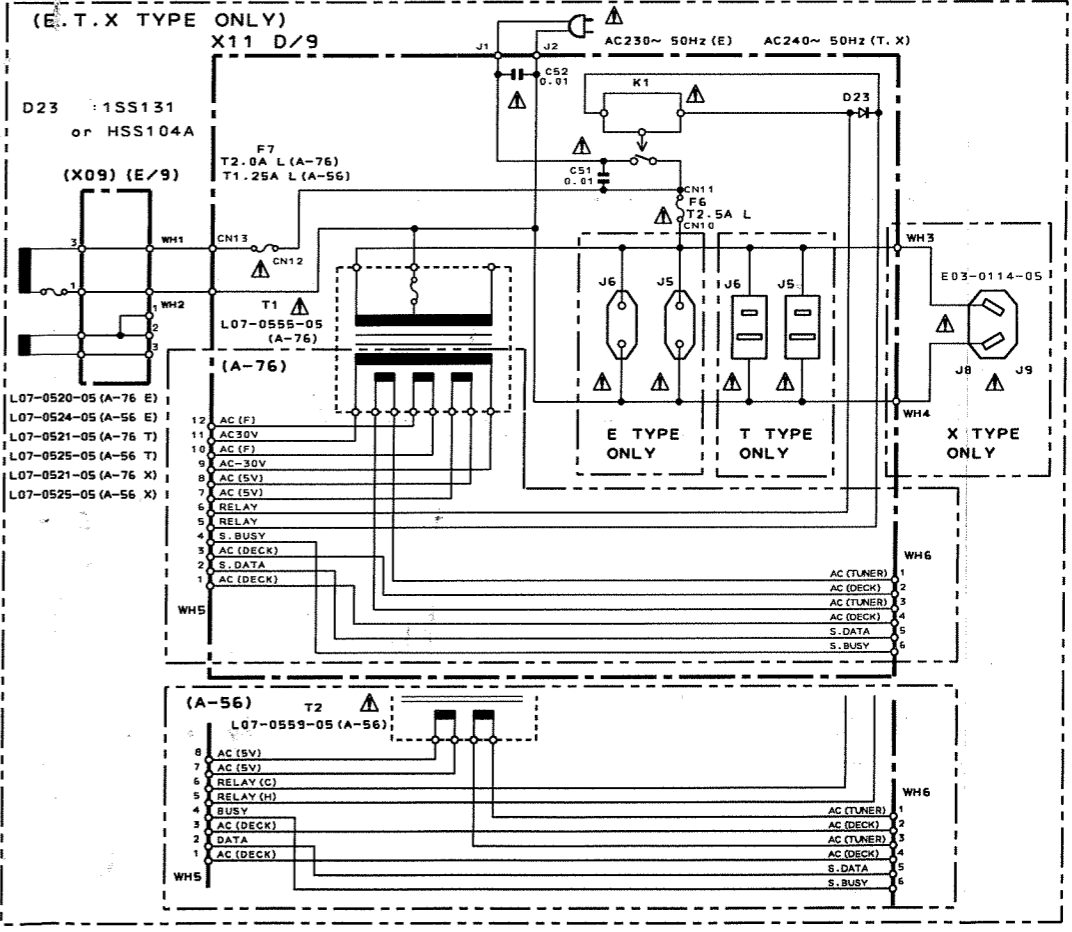
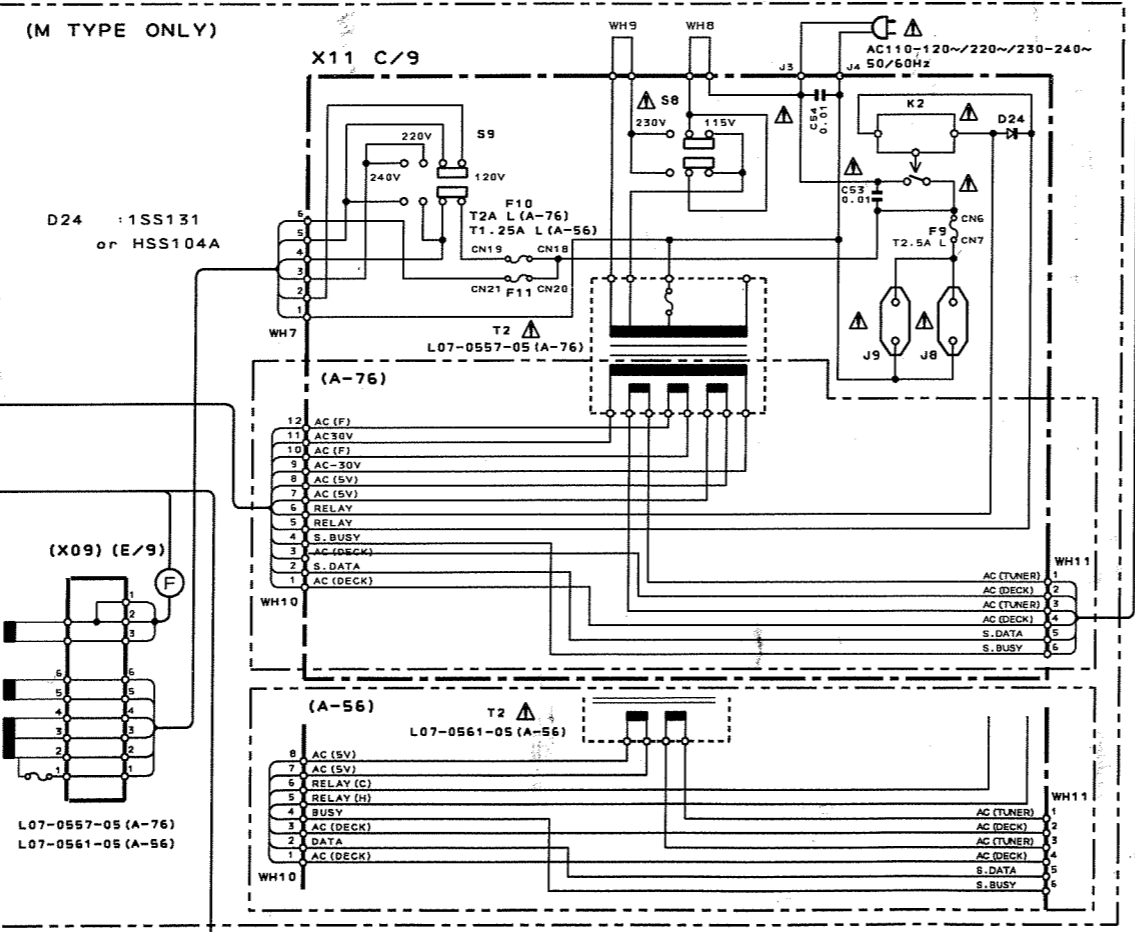
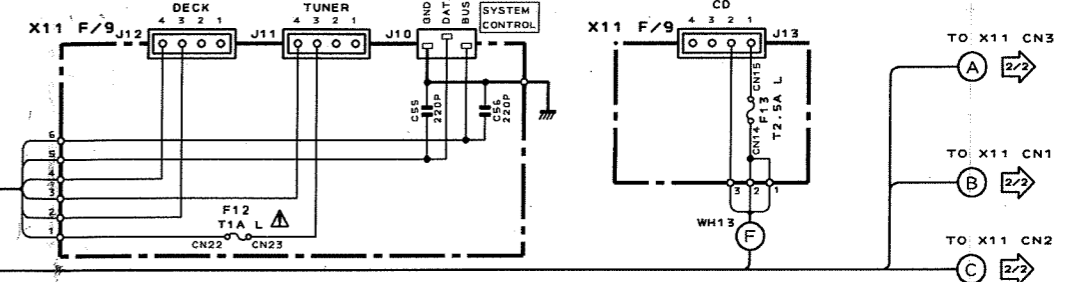

CAUTION: parts liable to risk of fire shall be the supplier's responsibility.

DC voltages with no load between terminals.

Les tenues impédances légères instrument.

Die an hochof gemessenen Unterseite U. gerir

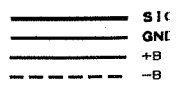

(A-76)

X11-33XX-XX (A/9)

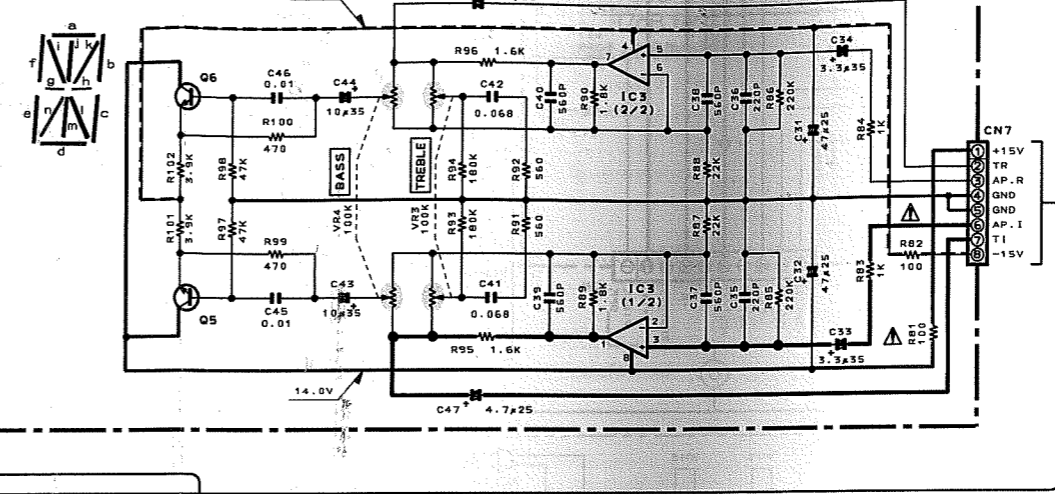
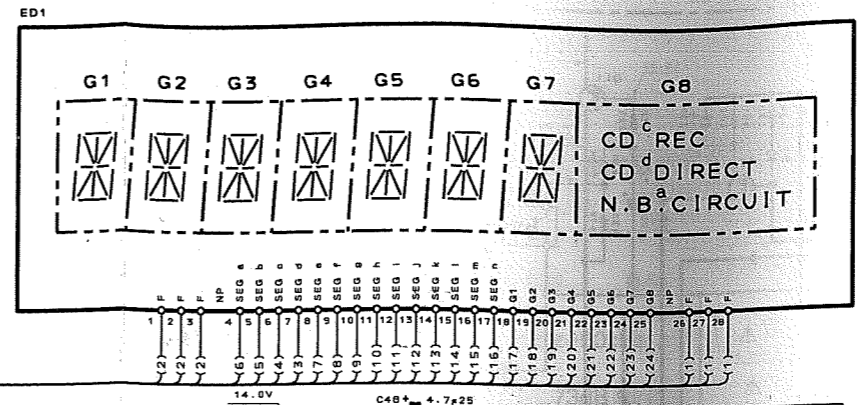
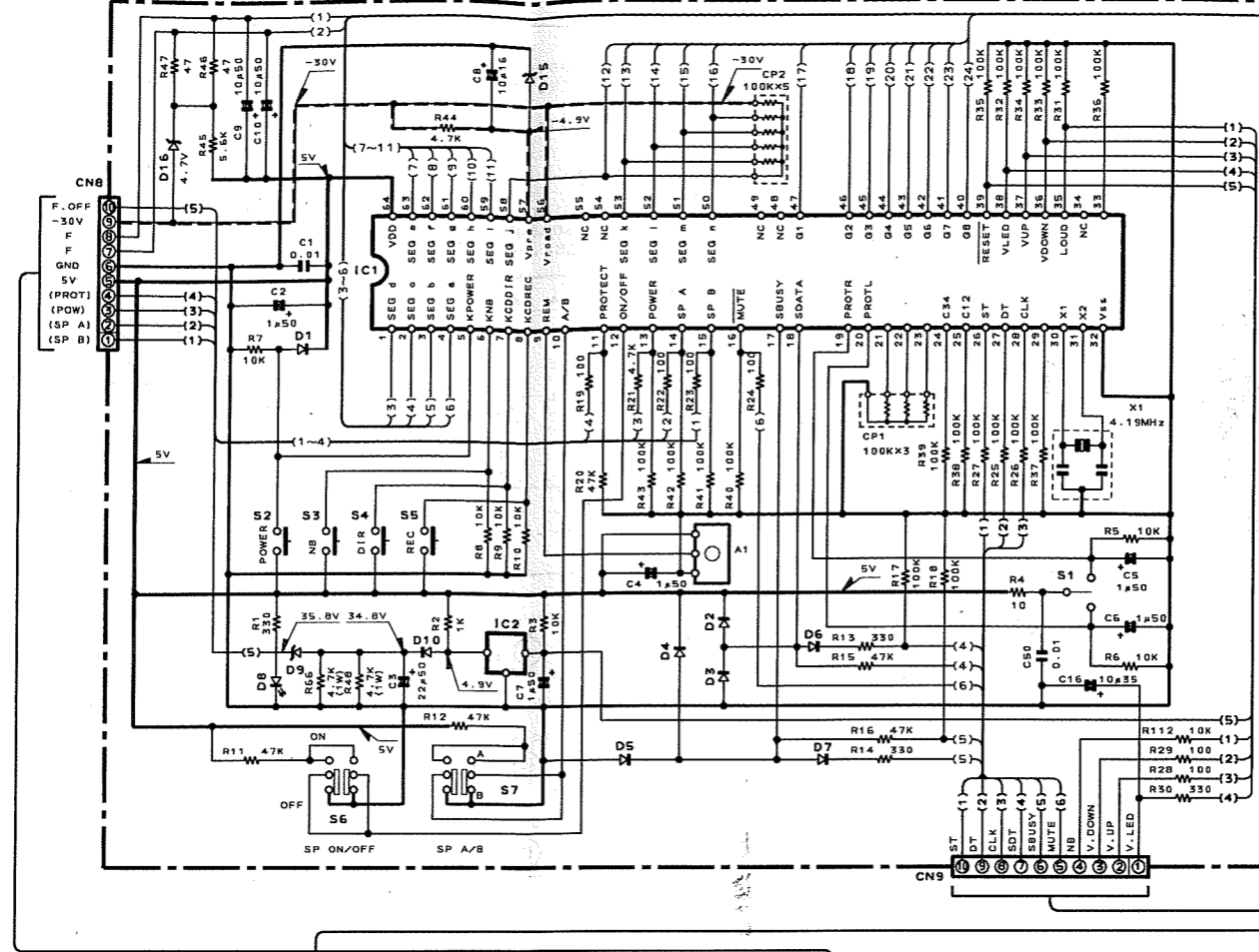

X11 B/9

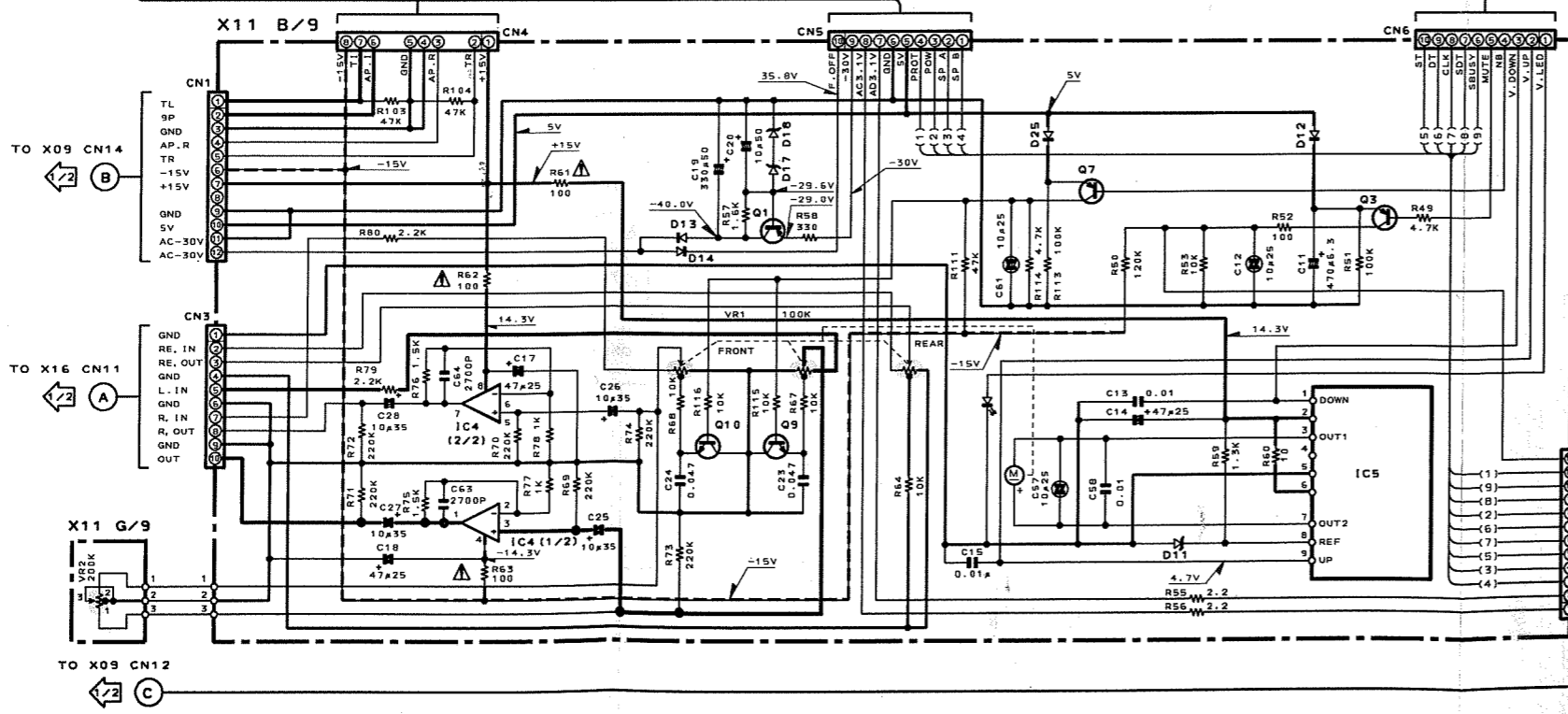

- IC1 : PD75268CW-044
- IC2 : PST529D
- IC3, 4 : NJM4565L-D
- IC5 : TA8409S
- Q1 : 2SA954 (L. K)
- Q3, 7 : 2SA1048 (Y. GR) (J)
- 2SA1309A (O. R) (J)
- 2SA1175 (F. E) (S)
- 2SA933S (O. R) (S)
- Q5, 6 : 2SC1845 (F. E)
- Q9, 10 : 2SC2878 (A. B)
- D1-7, 12, 25 : 1SS133 or HSS104
- D8 : B30-1291-05
- D9, 15 : RD5.1ES (B2) or HZS5.1N (B2)
- D10, 14, 23, 24 : 1SS131 or HSS104A
- D11, 16 : RD4.7ES (B2) or HZS4.7N (B2)
- D13 : S5688B
- D17 : RD15ES (B2) or HZS15N (B2)
- D18 : RD13ES (B2) or HZS13N (B2)
- D18 : RD13ES (B2) or HZS13N (B2)
- ED1 : CM1154C

MODEL	COUNTRY	
X11-332X-XX	M	GENERAL MARKET 0-21
A-76 (JAPAN MADE)	X	AUSTRALIA 0-71
	T	ENGLAND 0-51
	E	EUROPE 2-70
X11-334X-XX	M	GENERAL MARKET 0-21
A-76 (SINGAPOLE MADE)	X	AUSTRALIA 0-01
	T	ENGLAND 0-51
	E	EUROPE 2-70

(A-56)

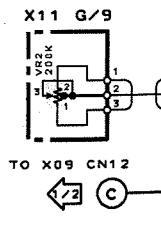
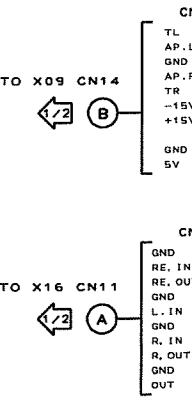

CAUTION  
 nents only  
 parts list).  
 risk of elec  
 shall be ca  
 the supply  
 er.

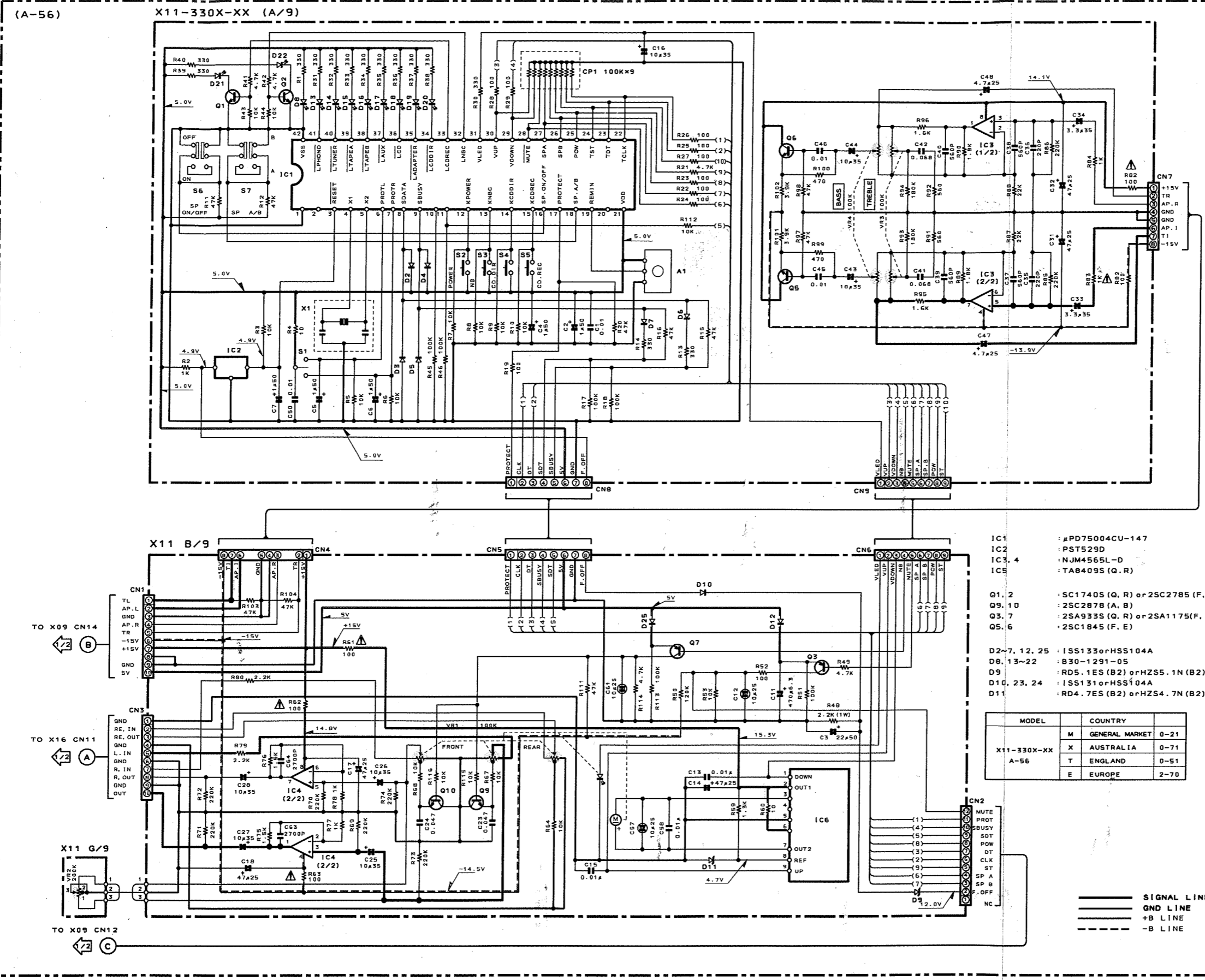

- HSS104
- HSS104A
- HZS4.7N
- HZS5.1N
- RD4.7ES
- RD5.1ES
- S5688B
- 1SR139-100
- 1SS131
- 1SS133

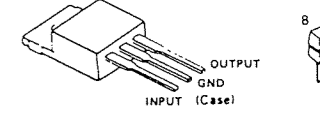

- 2SA954
- 2SA992
- 2SC1845
- 2SC2003
- 2SC2878

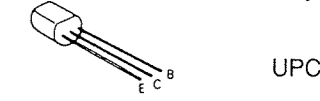

- 2SB1531
- 2SD2340

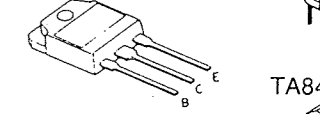

- 2SA1175
- 2SC2785

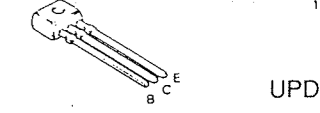

- DTC124ES
- 2SA1048
- 2SA933S
- 2SC1740S
- 2SC2458

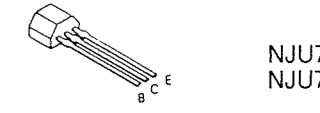

- 2SC4137



- 2SB1492
- 2SD2254



- IC1: #PD75004CU-147
- IC2: #PST529D
- IC3, 4: #NJM4565L-D
- IC5: #TA8409S (Q, R)
- Q1, 2: #SC1740S (Q, R) or 2SC2785 (F, E)
- Q9, 10: #2SC2878 (A, B)
- Q3, 7: #2SA933S (Q, R) or 2SA1175 (F, E)
- Q5, 6: #2SC1845 (F, E)
- D2-7, 12, 25: #1SS133 or HSS104A
- D8, 13-22: #B30-1291-05
- D9: #RD5.1ES (B2) or HZS5.1N (B2)
- D10, 23, 24: #1SS131 or HSS104A
- D11: #RD4.7ES (B2) or HZS4.7N (B2)

MODEL	COUNTRY	
X11-330X-XX A-56	M	GENERAL MARKET 0-21
	X	AUSTRALIA 0-71
	T	ENGLAND 0-51
	E	EUROPE 2-70

— SIGNAL LINE  
 — GND LINE  
 — +B LINE  
 - - - -B LINE

**CAUTION:** For continued safety, replace safety critical components only with manufacturer's recommended parts (refer to parts list).  $\Delta$  Indicates safety critical components. To reduce the risk of electric shock, leakage-current or resistance measurements shall be carried out (exposed parts are acceptably insulated from the supply circuit) before the appliance is returned to the customer.

DC voltages are as measured with a high impedance voltmeter with no signal input. Values may vary slightly due to variations between individual instruments or/and units.

Les tensions c.c. doivent être mesurées avec un voltmètre à haute impédance sans signal d'entrée. Les valeurs peuvent différer légèrement du fait des variations inhérentes aux appareils et aux instruments de mesure individuels.

Die angegebenen Gleichspannungswerte wurden mit einem hochohmigen Spannungsmesser ohne Eingangssignal gemessen. Dabei schwanken die Meßwerte aufgrund von Unterschieden zwischen einzelnen Instrumenten oder Geräten u. U. geringfügig.